

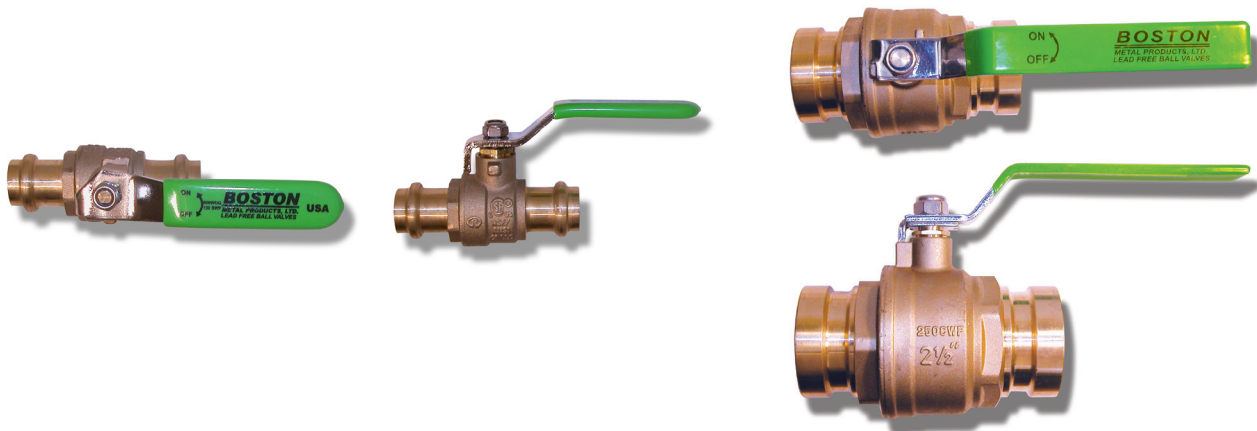

B-PRESS537LF

B-PRESS XLC



THE BOSTON VALVE Co.

A DIVISION OF BOSTON METAL PRODUCTS, LTD.

**25 THURBER BLVD., UNIT #3
SMITHFIELD, RI 02917**

**TOLL FREE: 1-800-839-0013, TEL: 401-231-8537
FAX: 401-231-8491**

WWW.BOSTONVALVE.COM

B-PRESS537LF, B-PRESS XLC SERIES FORGED BRASS BALL VALVE

A full port, quarter turn ball valve. ready for cold press installation. no fitting required. no welding, soldering or brazing required. Sizes 1/2" to 4".

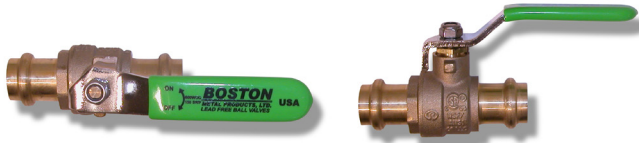

1/2" TO 2" STANDARD

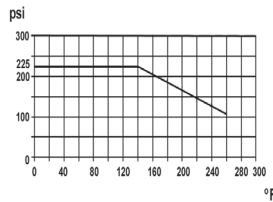
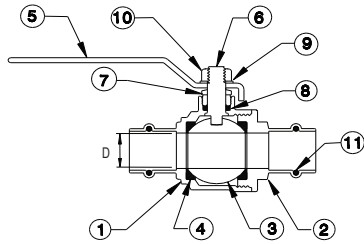
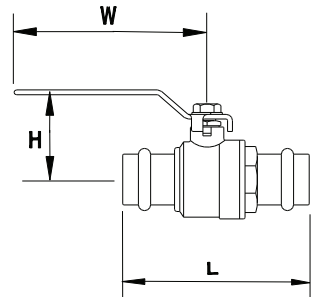

DIMENSIONS

CAT. NO.	SIZE	L	H	W	D
BP050537LF	1/2	3.07	2.05	3.66	.59
BP075537LF	3/4	3.62	2.20	3.66	.81
BP100537LF	1	3.86	2.64	4.41	.99
BP125537LF	1 1/4	4.30	2.76	4.41	1.18
BP150537LF	1 1/2	5.12	3.07	5.63	1.45
BP200537LF	2	5.99	3.39	5.63	1.88
BP250537LF	2 1/2	8.74	4.69	11.07	2.55
BP300537LF	3	9.45	5.14	11.07	3.07
BP400537LF	4	10.12	5.64	11.07	3.94

MATERIAL LIST

NO.	PART NAME	MATERIALS
11	O-RING	EPDM
10	NUT	ZINC PLATED STEEL
9	LOCK WASHER	ZINC PLATED STEEL
8	STEM PACKING	PTFE
7	GLAND NUT	BRASS
6	STEM	BRASS
5	HANDLE	ZINC PLATED STEEL, PLASTICOATED
4	SEAT	PTFE
3	BALL	BRASS, CHROME PLATED, EN 12164
2	END CAP	HOT FORGED BRASS EN 12165-CW602N
1	BODY	HOT FORGED BRASS EN 12165-CW602N

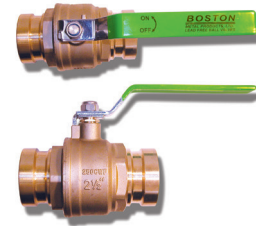

XLC 2 1/2" TO 4"

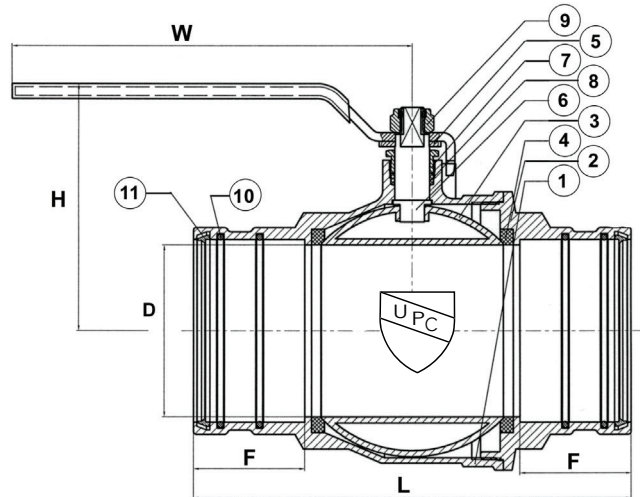

DIMENSIONS

CAT. NO.	SIZE	L	D	H	W	F
BP250XLCLF	2 1/2	7.03	2.52	4.55	9.05	1.85
BP300XLCLF	3	8.19	2.95	4.89	9.05	2.16
BP400XLCLF	4	9.90	3.90	5.59	9.05	2.52

MATERIAL LIST

NO.	PART NAME	MATERIAL
11	LOCKING RING	304 SST
10	O-RING	EPDM
9	LOCK NUT	304 SST
8	STEM PACKING	PTFE
7	GLAND NUT	BRASS, HPb59-3
6	STEM	BRASS, HPb59-3
5	HANDLE	ZINC PLATED STEEL, PLASTICOATED
4	SEAT	PTFE
3	BALL	304 SST
2	END CAP	FORGED LEAD FREE BRASS, C46500
1	BODY	FORGED LEAD FREE BRASS, C46500